



Grayhill, Inc.

## 62S11-L9-PH

Numero ng Bahagi:

62S11-L9-PH

Tagagawa / Brand:

Grayhill, Inc.

Paglalarawan ng produkto

ROTARY ENCODER OPTICAL 32PPR

Mga Datasheet:

 62S11-L9-PH.pdf

Katayuan ng RoHS

 Lead free / RoHS Compliant

Stock Kondisyon

1972 pcs stock

Ipadala Mula

Hong Kong

Pagpapadala ng Way

DHL/Fedex/TNT/UPS/EMS

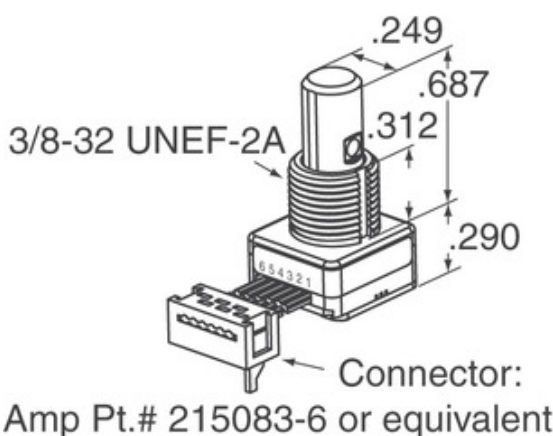

Connector:  
Amp Pt.# 215083-6 or equivalent

**HUMILING NG PANIPI**

Ang imahe ay maaaring representasyon. Tingnan ang mga pagtutukoy para sa mga detalye ng produkto.







### Mga pagtutukoy ng 62S11-L9-PH

NUMERO NG BAHAGI	62S11-L9-PH
MANUFACTURER	Grayhill, Inc.
PAGLALARAWAN	ROTARY ENCODER OPTICAL 32PPR
LEAD FREE STATUS / KATAYUAN NG ROHS	Lead free / RoHS Compliant
AVAILABLE ANG DAMI	1972 pcs
DATA SHEET	 62S11-L9-PH.pdf
BOLTAHE - SUPPLY	5V
PAGWAWAKAS STYLE	PC Pin
SERYE	62S
PALITIN LIFE (CYCLES MIN)	1M
PULSES PER REVOLUTION	32
TYPE OUTPUT	Quadrature (Incremental)
IBANG PANGALAN	62S11L9PH
ORYENTASYON	Vertical
SALALAYAN TYPE	PCB, Through Hole
ANG SENSITIVITY LEVEL (MSL)	1 (Unlimited)
LEAD LIBRENG STATUS / KATAYUAN NG ROHS	Lead free / RoHS Compliant
TYPE ENCODER	Optical
DITENT	Yes
ITINAYO NOONG LUMIPAT	Yes
TYPE ACTUATOR	1/4" Dia Flatted End

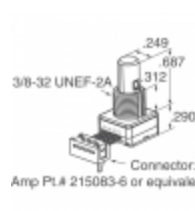
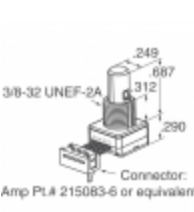
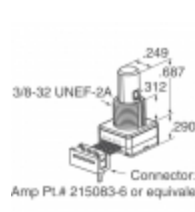
### Kaugnay na Mga Tag

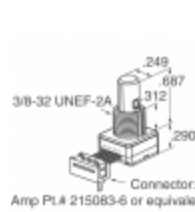
Grayhill, Inc. 62S11-L9-PH	62S11-L9-PH Distributor	62S11-L9-PH Supplier
62S11-L9-PH Presyo	62S11-L9-PH Pictures	62S11-L9-PH Image
62S11-L9-PH PDF Datasheet	62S11-L9-PH I-download ang Datasheet	62S11-L9-PH Datasheet
62S11-L9-PH Stock	Bumili ng 62S11-L9-PH	Bumili Grayhill, Inc. 62S11-L9-PH
Grayhill, Inc. 62S11-L9-PH	Grayhill, Inc. Supplier	Grayhill, Inc. Distributor
Grayhill, Inc. 62S11-L9-PH	Grayhill Inc. 62S11-L9-PH	

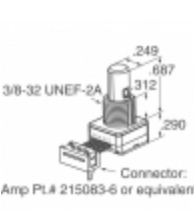
### Kaugnay na Mga Produkto

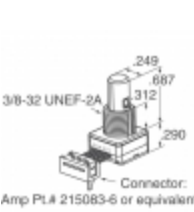
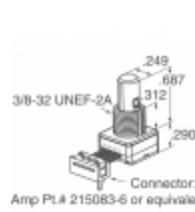
 <p><b>62S11-L9-020CH</b> Mga Tagagawa: Grayhill, Inc. Paglalarawan: ROTARY ENCODER OPTICAL 32PPR Sa stock: 2264 pcs</p> <p><b>RFQ</b></p>	 <p><b>62S11-M0-030CH</b> Mga Tagagawa: Grayhill, Inc. Paglalarawan: ROTARY ENCODER OPTICAL 32PPR Sa stock: 2151 pcs</p> <p><b>RFQ</b></p>
 <p><b>62S11-L9-040C</b> Mga Tagagawa: Grayhill, Inc. Paglalarawan: ROTARY ENCODER OPTICAL 32PPR Sa stock: 1938 pcs</p> <p><b>RFQ</b></p>	 <p><b>62S11-L9-020C</b> Mga Tagagawa: Grayhill, Inc. Paglalarawan: ROTARY ENCODER OPTICAL 32PPR Sa stock: 1773 pcs</p> <p><b>RFQ</b></p>
 <p><b>62S11-M0-040CH</b> Mga Tagagawa: Grayhill, Inc. Paglalarawan: ROTARY ENCODER OPT 32PPR 2" CBL Sa stock: 1915 pcs</p> <p><b>RFQ</b></p>	 <p><b>62S11-M0-020SH</b> Mga Tagagawa: Grayhill, Inc. Paglalarawan: ROTARY ENCODER OPT 32PPR 2" CBL Sa stock: 2051 pcs</p> <p><b>RFQ</b></p>
 <p><b>62S11-M0-050C</b> Mga Tagagawa: Grayhill, Inc. Paglalarawan: ROTARY ENCODER OPT 32PPR 5" CBL Sa stock: 2292 pcs</p> <p><b>RFQ</b></p>	 <p><b>62S11-M0-060C</b> Mga Tagagawa: Grayhill, Inc. Paglalarawan: ROTARY ENCODER OPT 32PPR 6" CBL Sa stock: 2289 pcs</p> <p><b>RFQ</b></p>
 <p><b>62S11-M0-020C</b> Mga Tagagawa: Grayhill, Inc. Paglalarawan: ROTARY ENCODER OPT 32PPR 2" CBL Sa stock: 1812 pcs</p> <p><b>RFQ</b></p>	 <p><b>62S11-L5-PH</b> Mga Tagagawa: Grayhill, Inc. Paglalarawan: ROTARY ENCODER OPTICAL 32PPR Sa stock: 2218 pcs</p> <p><b>RFQ</b></p>
 <p><b>62S11-L9-020SH</b> Mga Tagagawa: Grayhill, Inc. Paglalarawan: ROTARY ENCODER OPTICAL 32PPR Sa stock: 1952 pcs</p> <p><b>RFQ</b></p>	 <p><b>62S11-L9-020S</b> Mga Tagagawa: Grayhill, Inc. Paglalarawan: ROTARY ENCODER OPTICAL 32PPR Sa stock: 2134 pcs</p> <p><b>RFQ</b></p>

Copyright © 2020 maasahang distributor ng electronic components.

E-mail: [Info@infinity-electronic.com](mailto:Info@infinity-electronic.com)

Address: 17F, Gaylord Commercial Building, 114-118 Lockhart Road, Wan Chai, Hong Kong

