



Grayhill, Inc.

62S11-N9-060C

Numero ng Bahagi: 62S11-N9-060C

Tagagawa / Brand: Grayhill, Inc.

Paglalarawan ng produkto: ROTARY ENCODER OPTICAL 32PPR

Mga Datasheet: [PDF 62S11-N9-060C.pdf](#)Katayuan ng RoHS:  Lead free / RoHS Compliant

Stock Kondisyon: 2192 pcs stock

Ipadala Mula: Hong Kong

Pagpapadala ng Way: DHL/Fedex/TNT/UPS/EMS

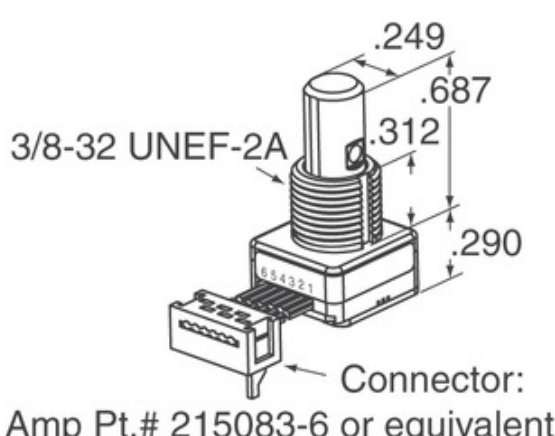
**HUMILING NG PANIPI**

Ang imahe ay maaaring representasyon. Tingnan ang mga pagtutukoy para sa mga detalye ng produkto.







Mga pagtutukoy ng 62S11-N9-060C

NUMERO NG BAHAGI	62S11-N9-060C
MANUFACTURER	Grayhill, Inc.
PAGLALARAWAN	ROTARY ENCODER OPTICAL 32PPR
LEAD FREE STATUS / KATAYUAN NG ROHS	Lead free / RoHS Compliant
AVAILABLE ANG DAMI	2192 pcs
DATA SHEET	PDF 62S11-N9-060C.pdf
BOLTAHE - SUPPLY	5V
PAGWAWAKAS STYLE	Cable with Connector
SERYE	62S
PALITIN LIFE (CYCLES MIN)	1M
PULSES PER REVOLUTION	32
TYPE OUTPUT	Quadrature (Incremental)
IBANG PANGALAN	62S11N9060C
ORYENTASYON	Vertical
SALALAYAN TYPE	Panel Mount
ANG SENSITIVITY LEVEL (MSL)	1 (Unlimited)
LEAD LIBRENG STATUS / KATAYUAN NG ROHS	Lead free / RoHS Compliant
TYPE ENCODER	Optical
DITENT	No
ITINAYO NOONG LUMIPAT	Yes
TYPE ACTUATOR	1/4" Dia Flatted End

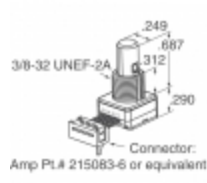
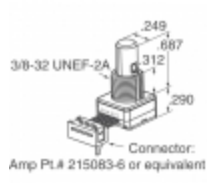
Kaugnay na Mga Tag

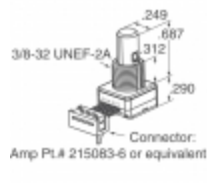
Grayhill, Inc. 62S11-N9-060C	62S11-N9-060C Distributor	62S11-N9-060C Supplier
62S11-N9-060C Presyo	62S11-N9-060C Pictures	62S11-N9-060C Image
62S11-N9-060C PDF Datasheet	62S11-N9-060C I-download ang Datasheet	62S11-N9-060C Datasheet
62S11-N9-060C Stock	Bumili ng 62S11-N9-060C	Bumili Grayhill, Inc. 62S11-N9-060C
Grayhill, Inc. 62S11-N9-060C	Grayhill, Inc. Supplier	Grayhill, Inc. Distributor
Grayhill, Inc. 62S11-N9-060C	Grayhill Inc. 62S11-N9-060C	

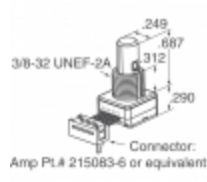
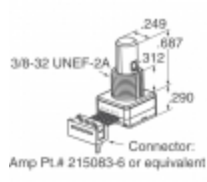
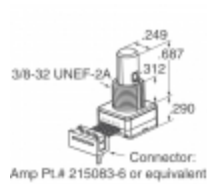
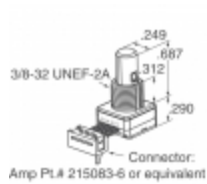
Kaugnay na Mga Produkto

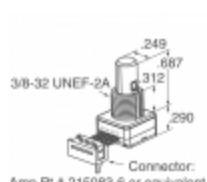
 <p>62S11-N5-060SH Mga Tagagawa: Grayhill, Inc. Paglalarawan: ROTARY ENCODER OPTICAL 32PPR Sa stock: 2263 pcs</p> <p>RFQ</p>	 <p>62S11-N9-060SH Mga Tagagawa: Grayhill, Inc. Paglalarawan: ROTARY ENCODER OPTICAL 32PPR Sa stock: 1801 pcs</p> <p>RFQ</p>
 <p>62S15-H0-020C Mga Tagagawa: Grayhill, Inc. Paglalarawan: ROTARY ENCODER OPTICAL 24PPR Sa stock: 2286 pcs</p> <p>RFQ</p>	 <p>62S15-H0-040CH Mga Tagagawa: Grayhill, Inc. Paglalarawan: ROTARY ENCODER OPTICAL 24PPR Sa stock: 1921 pcs</p> <p>RFQ</p>
 <p>62S11-N5-080SH Mga Tagagawa: Grayhill, Inc. Paglalarawan: ROTARY ENCODER OPTICAL 32PPR Sa stock: 1942 pcs</p> <p>RFQ</p>	 <p>62S11-N5-PV Mga Tagagawa: Grayhill, Inc. Paglalarawan: ROTARY ENCODER OPTICAL 32PPR Sa stock: 2220 pcs</p> <p>RFQ</p>
 <p>62S11-N9-PH Mga Tagagawa: Grayhill, Inc. Paglalarawan: ROTARY ENCODER OPTICAL 32PPR Sa stock: 2219 pcs</p> <p>RFQ</p>	 <p>62S11-N5-100C Mga Tagagawa: Grayhill, Inc. Paglalarawan: ROTARY ENCODER OPTICAL 32PPR Sa stock: 1789 pcs</p> <p>RFQ</p>
 <p>62S11-N9-120S Mga Tagagawa: Grayhill, Inc. Paglalarawan: ROTARY ENCODER OPTICAL 32PPR Sa stock: 1784 pcs</p> <p>RFQ</p>	 <p>62S11-N5-120S Mga Tagagawa: Grayhill, Inc. Paglalarawan: ROTARY ENCODER OPTICAL 32PPR Sa stock: 1675 pcs</p> <p>RFQ</p>
 <p>62S15-H0-040C Mga Tagagawa: Grayhill, Inc. Paglalarawan: ROTARY ENCODER OPTICAL 24PPR Sa stock: 1793 pcs</p> <p>RFQ</p>	 <p>62S11-N5-P Mga Tagagawa: Grayhill, Inc. Paglalarawan: ROTARY ENCODER OPTICAL 32PPR Sa stock: 1885 pcs</p> <p>RFQ</p>

Copyright © 2020 maasahang distributor ng electronic components.

E-mail: Info@infinity-electronic.com

Address: 17F, Gaylord Commercial Building, 114-118 Lockhart Road, Wan Chai, Hong Kong

