

**Panasonic**

Panasonic

### JQ1-B-18V-F

Numero ng Bahagi:

Tagagawa / Brand:

Paglalarawan ng produkto

Mga Datasheet:

Katayuan ng RoHS

Stock Kondisyon

Ipadala Mula

Pagpapadala ng Way

JQ1-B-18V-F

Panasonic

JQ RELAY 1 FORM C 18V

[JQ1-B-18V-F.pdf](#)

Lead free / RoHS Compliant

39018 pcs stock

Hong Kong

DHL/Fedex/TNT/UPS/EMS

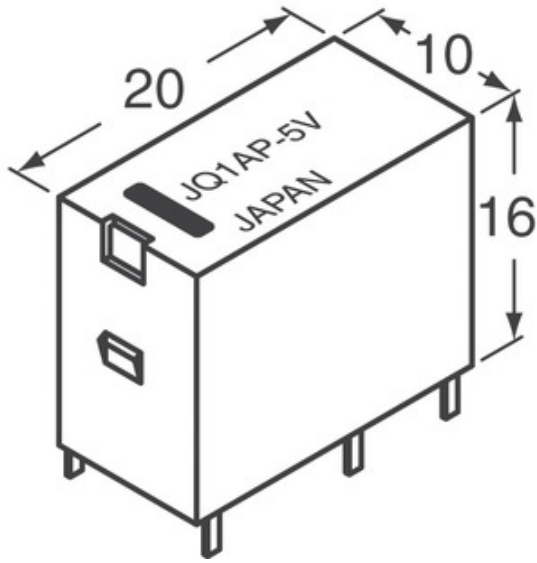

**HUMILING NG PANIPI**

Ang imahe ay maaaring representasyon. Tingnan ang mga pagtutukoy para sa mga detalye ng produkto.

#### Mga pagtutukoy ng JQ1-B-18V-F

NUMERO NG BAHAGI	JQ1-B-18V-F
MANUFACTURER	Panasonic
PAGLALARAWAN	JQ RELAY 1 FORM C 18V
LEAD FREE STATUS / KATAYUAN NG ROHS	Lead free / RoHS Compliant
AVAILABLE ANG DAMI	39018 pcs
DATA SHEET	<a href="#">JQ1-B-18V-F.pdf</a>
SERYE	*
ANG SENSITIVITY LEVEL (MSL)	1 (Unlimited)
LEAD LIBRENG STATUS / KATAYUAN NG ROHS	Lead free / RoHS Compliant
DETALYADONG PAGLALARAWAN	Relay Coil

#### Kaugnay na Mga Tag

Panasonic JQ1-B-18V-F	JQ1-B-18V-F Distributor	JQ1-B-18V-F Supplier
JQ1-B-18V-F Presyo	JQ1-B-18V-F Pictures	JQ1-B-18V-F Image
JQ1-B-18V-F PDF Datasheet	JQ1-B-18V-F I-download ang Datasheet	JQ1-B-18V-F Datasheet
JQ1-B-18V-F Stock	Bumili ng JQ1-B-18V-F	Bumili Panasonic JQ1-B-18V-F
Panasonic JQ1-B-18V-F	Panasonic Supplier	Panasonic Distributor
Panasonic JQ1-B-18V-F	Panasonic - Consumer Division JQ1-B-18V-F	Panasonic - Consumer Electronics Corp. JQ1-B-18V-F
Panasonic Battery Group JQ1-B-18V-F	Panasonic Electric Works - ACSD JQ1-B-18V-F	Panasonic Electronic Components - Semiconductor Pr JQ1-B-18V-F
Panasonic - ATG JQ1-B-18V-F	Panasonic - BSG JQ1-B-18V-F	Panasonic - DTG JQ1-B-18V-F
Panasonic Electric Works JQ1-B-18V-F	Panasonic Electronic Components JQ1-B-18V-F	Panasonic Industrial Automation Sales JQ1-B-18V-F
Panasonic Semiconductor JQ1-B-18V-F		

#### Kaugnay na Mga Produkto

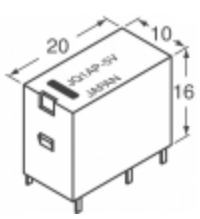

#### JQ1-B-9V-F

Mga Tagagawa: Panasonic  
Paglalarawan: JQ RELAY 1 FORM C 9V  
Sa stock: 41857 pcs

**RFQ**



#### JQ1-9V

Mga Tagagawa: Panasonic  
Paglalarawan: RELAY GENERAL PURPOSE SPDT 5A 9V  
Sa stock: 3646 pcs

**RFQ**

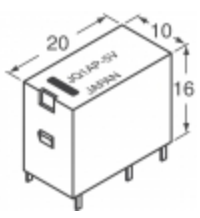

#### JQ1-F-5V-F

Mga Tagagawa: Panasonic  
Paglalarawan: JQ RELAY 1 FORM C 5V  
Sa stock: 49961 pcs

**RFQ**



#### JQ1-5V-F

Mga Tagagawa: Panasonic  
Paglalarawan: RELAY GENERAL PURPOSE SPDT 5A 5V  
Sa stock: 18344 pcs

**RFQ**

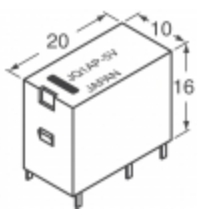

#### JQ1-B-12V-F

Mga Tagagawa: Panasonic  
Paglalarawan: RELAY GEN PURPOSE SPDT 5A 12V  
Sa stock: 33903 pcs

**RFQ**



#### JQ1-6V

Mga Tagagawa: Panasonic  
Paglalarawan: RELAY GENERAL PURPOSE SPDT 5A 6V  
Sa stock: 5303 pcs

**RFQ**

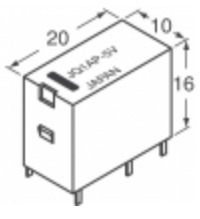

#### JQ1-B-5V-F

Mga Tagagawa: Panasonic  
Paglalarawan: JQ RELAY 1 FORM C 5V  
Sa stock: 48004 pcs

**RFQ**



#### JQ1-6V-F

Mga Tagagawa: Panasonic  
Paglalarawan: RELAY GENERAL PURPOSE SPDT 5A 6V  
Sa stock: 25493 pcs

**RFQ**

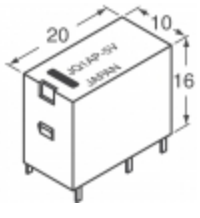

#### JQ1-B-24V-F

Mga Tagagawa: Panasonic  
Paglalarawan: JQ RELAY 1 FORM C 24V  
Sa stock: 39522 pcs

**RFQ**

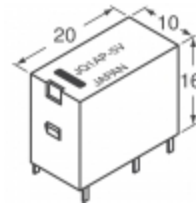

#### JQ1-B-6V-F

Mga Tagagawa: Panasonic  
Paglalarawan: JQ RELAY 1 FORM C 6V  
Sa stock: 46529 pcs

**RFQ**

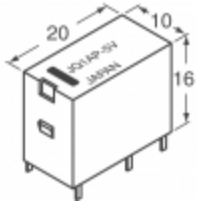

#### JQ1-B-48V-F

Mga Tagagawa: Panasonic  
Paglalarawan: JQ RELAY 1 FORM C 48V  
Sa stock: 41459 pcs

**RFQ**



#### JQ1-9V-F

Mga Tagagawa: Panasonic  
Paglalarawan: RELAY GENERAL PURPOSE SPDT 5A 9V  
Sa stock: 31079 pcs

**RFQ**