



Is Now Part of



ON Semiconductor®

To learn more about ON Semiconductor, please visit our website at
www.onsemi.com

Please note: As part of the Fairchild Semiconductor integration, some of the Fairchild orderable part numbers will need to change in order to meet ON Semiconductor's system requirements. Since the ON Semiconductor product management systems do not have the ability to manage part nomenclature that utilizes an underscore (_), the underscore (_) in the Fairchild part numbers will be changed to a dash (-). This document may contain device numbers with an underscore (_). Please check the ON Semiconductor website to verify the updated device numbers. The most current and up-to-date ordering information can be found at www.onsemi.com. Please email any questions regarding the system integration to Fairchild_questions@onsemi.com.

ON Semiconductor and the ON Semiconductor logo are trademarks of Semiconductor Components Industries, LLC dba ON Semiconductor or its subsidiaries in the United States and/or other countries. ON Semiconductor owns the rights to a number of patents, trademarks, copyrights, trade secrets, and other intellectual property. A listing of ON Semiconductor's product/patent coverage may be accessed at www.onsemi.com/site/pdf/Patent-Marking.pdf. ON Semiconductor reserves the right to make changes without further notice to any products herein. ON Semiconductor makes no warranty, representation or guarantee regarding the suitability of its products for any particular purpose, nor does ON Semiconductor assume any liability arising out of the application or use of any product or circuit, and specifically disclaims any and all liability, including without limitation special, consequential or incidental damages. Buyer is responsible for its products and applications using ON Semiconductor products, including compliance with all laws, regulations and safety requirements or standards, regardless of any support or applications information provided by ON Semiconductor. "Typical" parameters which may be provided in ON Semiconductor data sheets and/or specifications can and do vary in different applications and actual performance may vary over time. All operating parameters, including "Typicals" must be validated for each customer application by customer's technical experts. ON Semiconductor does not convey any license under its patent rights nor the rights of others. ON Semiconductor products are not designed, intended, or authorized for use as a critical component in life support systems or any FDA Class 3 medical devices or medical devices with a same or similar classification in a foreign jurisdiction or any devices intended for implantation in the human body. Should Buyer purchase or use ON Semiconductor products for any such unintended or unauthorized application, Buyer shall indemnify and hold ON Semiconductor and its officers, employees, subsidiaries, affiliates, and distributors harmless against all claims, costs, damages, and expenses, and reasonable attorney fees arising out of, directly or indirectly, any claim of personal injury or death associated with such unintended or unauthorized use, even if such claim alleges that ON Semiconductor was negligent regarding the design or manufacture of the part. ON Semiconductor is an Equal Opportunity/Affirmative Action Employer. This literature is subject to all applicable copyright laws and is not for resale in any manner.



May 2016

FDMD8680

Dual N-Channel PowerTrench[®] MOSFET

80 V, 66 A, 4.7 mΩ

Features

- Common Source Configuration to Eliminate PCB Routing
- Large Source Pad on Bottom of Package for Enhanced Thermals
- Max $r_{DS(on)}$ = 4.7 mΩ at $V_{GS} = 10\text{ V}$, $I_D = 16\text{ A}$
- Max $r_{DS(on)}$ = 6.4 mΩ at $V_{GS} = 8\text{ V}$, $I_D = 14\text{ A}$
- Ideal for Flexible Layout in Secondary Side Synchronous Rectification
- 100% UIL Tested
- Termination is Lead-free and RoHS Compliant



General Description

This package integrates two N-Channel devices connected internally in common-source configuration. This enables very low package parasitics and optimized thermal path to the common source pad on the bottom. Provides a very small footprint (5 x 6 mm) for higher power density.

Applications

- Isolated DC-DC Synchronous Rectifiers
- Common Ground Load Switches

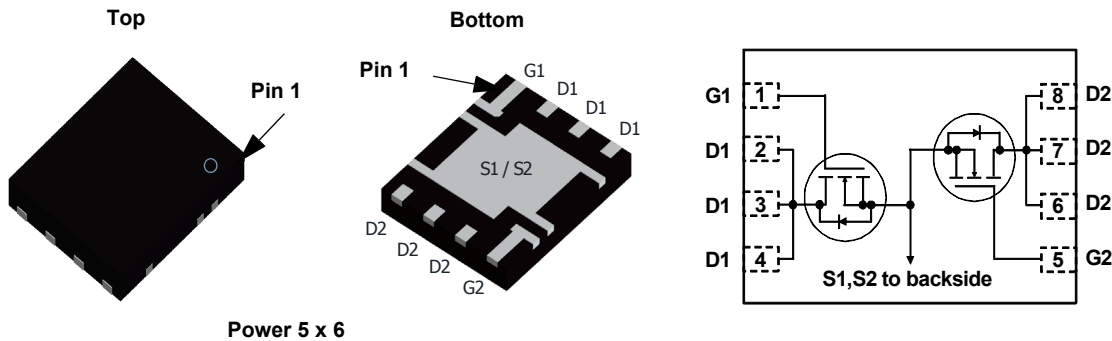

Power 5 x 6

MOSFET Maximum Ratings $T_A = 25\text{ °C}$ unless otherwise noted.

Symbol	Parameter	Ratings	Units
V_{DS}	Drain to Source Voltage	80	V
V_{GS}	Gate to Source Voltage	±20	V
I_D	Drain Current -Continuous	$T_C = 25\text{ °C}$ (Note 5)	66
	-Continuous	$T_C = 100\text{ °C}$ (Note 5)	42
	-Continuous	$T_A = 25\text{ °C}$ (Note 1a)	16
	-Pulsed	(Note 4)	487
E_{AS}	Single Pulse Avalanche Energy	(Note 3)	337
P_D	Power Dissipation	$T_C = 25\text{ °C}$	39
	Power Dissipation	$T_A = 25\text{ °C}$ (Note 1a)	2.3
T_J, T_{STG}	Operating and Storage Junction Temperature Range	-55 to +150	°C

Thermal Characteristics

$R_{\theta JC}$	Thermal Resistance, Junction to Case	3.2	°C/W
$R_{\theta JA}$	Thermal Resistance, Junction to Ambient (Note 1a)	55	

Package Marking and Ordering Information

Device Marking	Device	Package	Reel Size	Tape Width	Quantity
FDMD8680	FDMD8680	Power 5 x 6	13 "	12 mm	3000 units

Electrical Characteristics $T_J = 25\text{ }^\circ\text{C}$ unless otherwise noted.

Symbol	Parameter	Test Conditions	Min.	Typ.	Max.	Units
--------	-----------	-----------------	------	------	------	-------

Off Characteristics

BV_{DSS}	Drain to Source Breakdown Voltage	$I_D = 250\text{ }\mu\text{A}$, $V_{GS} = 0\text{ V}$	80			V
$\frac{\Delta BV_{DSS}}{\Delta T_J}$	Breakdown Voltage Temperature Coefficient	$I_D = 250\text{ }\mu\text{A}$, referenced to $25\text{ }^\circ\text{C}$		50		mV/ $^\circ\text{C}$
I_{DSS}	Zero Gate Voltage Drain Current	$V_{DS} = 64\text{ V}$, $V_{GS} = 0\text{ V}$			1	μA
I_{GSS}	Gate to Source Leakage Current	$V_{GS} = \pm 20\text{ V}$, $V_{DS} = 0\text{ V}$			± 100	nA

On Characteristics

$V_{GS(th)}$	Gate to Source Threshold Voltage	$V_{GS} = V_{DS}$, $I_D = 250\text{ }\mu\text{A}$	2.0	3.0	4.0	V
$\frac{\Delta V_{GS(th)}}{\Delta T_J}$	Gate to Source Threshold Voltage Temperature Coefficient	$I_D = 250\text{ }\mu\text{A}$, referenced to $25\text{ }^\circ\text{C}$		-10		mV/ $^\circ\text{C}$
$r_{DS(on)}$	Static Drain to Source On Resistance	$V_{GS} = 10\text{ V}$, $I_D = 16\text{ A}$		3.3	4.7	m Ω
		$V_{GS} = 8\text{ V}$, $I_D = 14\text{ A}$		3.9	6.4	
		$V_{GS} = 10\text{ V}$, $I_D = 16\text{ A}$, $T_J = 125\text{ }^\circ\text{C}$		5.6	8.0	
g_{FS}	Forward Transconductance	$V_{DD} = 10\text{ V}$, $I_D = 16\text{ A}$		49		S

Dynamic Characteristics

C_{iss}	Input Capacitance	$V_{DS} = 40\text{ V}$, $V_{GS} = 0\text{ V}$ $f = 1\text{ MHz}$		3805	5330	pF
C_{oss}	Output Capacitance			657	920	pF
C_{rss}	Reverse Transfer Capacitance			26	77	pF
R_g	Gate Resistance		0.1	1.7	3.4	Ω

Switching Characteristics

$t_{d(on)}$	Turn-On Delay Time	$V_{DD} = 40\text{ V}$, $I_D = 16\text{ A}$ $V_{GS} = 10\text{ V}$, $R_{GEN} = 6\text{ }\Omega$		20	32	ns
t_r	Rise Time			18	32	ns
$t_{d(off)}$	Turn-Off Delay Time			30	48	ns
t_f	Fall Time			10	20	ns
$Q_{g(TOT)}$	Total Gate Charge		$V_{GS} = 0\text{ V to }10\text{ V}$		53	73
Q_{gs}	Gate to Source Charge	$V_{DD} = 40\text{ V}$ $I_D = 16\text{ A}$		17		nC
Q_{gd}	Gate to Drain "Miller" Charge			10		nC

Drain-Source Diode Characteristics

V_{SD}	Source to Drain Diode Forward Voltage	$V_{GS} = 0\text{ V}$, $I_S = 16\text{ A}$ (Note 2)		0.8	1.3	V
V_{SD}	Source to Drain Diode Forward Voltage	$V_{GS} = 0\text{ V}$, $I_S = 2\text{ A}$ (Note 2)		0.7	1.2	V
t_{rr}	Reverse Recovery Time	$I_F = 16\text{ A}$, $di/dt = 100\text{ A}/\mu\text{s}$		48	77	ns
Q_{rr}	Reverse Recovery Charge			39	62	nC

NOTES:

1. $R_{\theta JA}$ is determined with the device mounted on a 1 in^2 pad 2 oz copper pad on a $1.5 \times 1.5\text{ in.}$ board of FR-4 material. $R_{\theta CA}$ is determined by the user's board design.

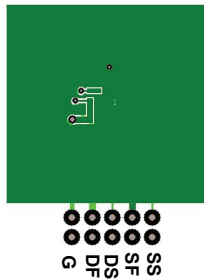

a. $55\text{ }^\circ\text{C/W}$ when mounted on a 1 in^2 pad of 2 oz copper

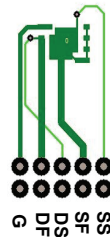

b. $125\text{ }^\circ\text{C/W}$ when mounted on a minimum pad of 2 oz copper

2. Pulse Test: Pulse Width < $300\text{ }\mu\text{s}$, Duty cycle < 2.0% .

3. E_{AS} of 337 mJ is based on starting $T_J = 25\text{ }^\circ\text{C}$, $L = 3\text{ mH}$, $I_{AS} = 15\text{ A}$, $V_{DD} = 80\text{ V}$, $V_{GS} = 10\text{ V}$. 100% tested at $L = 0.1\text{ mH}$, $I_{AS} = 49\text{ A}$.

4. Pulsed I_d please refer to Fig 11 SOA graph for more details.

5. Computed continuous current limited to Max Junction Temperature only, actual continuous current will be limited by thermal & electro-mechanical application board design.

Typical Characteristics $T_J = 25\text{ }^\circ\text{C}$ unless otherwise noted.

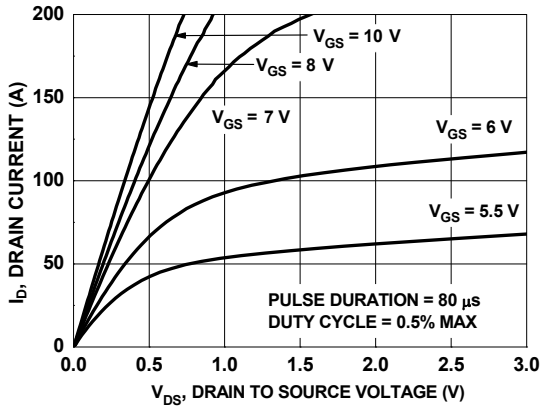

Figure 1. On-Region Characteristics

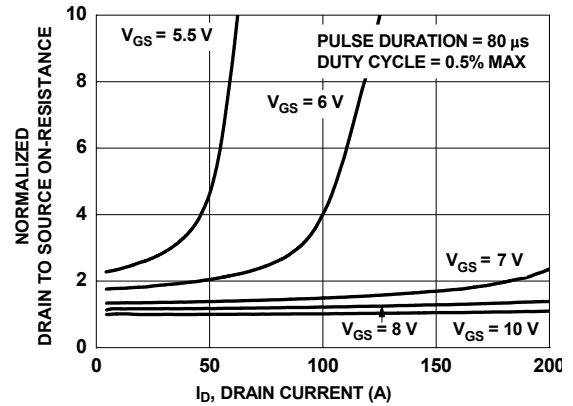

Figure 2. Normalized On-Resistance vs. Drain Current and Gate Voltage

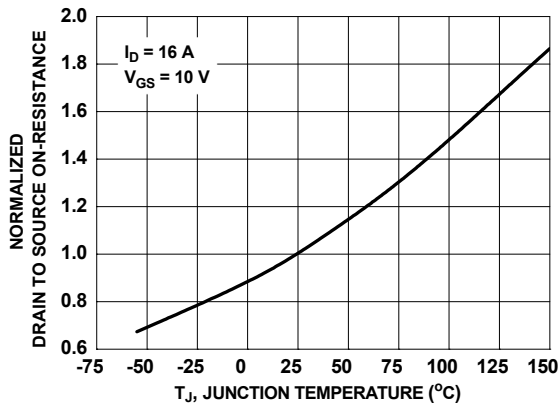

Figure 3. Normalized On Resistance vs. Junction Temperature

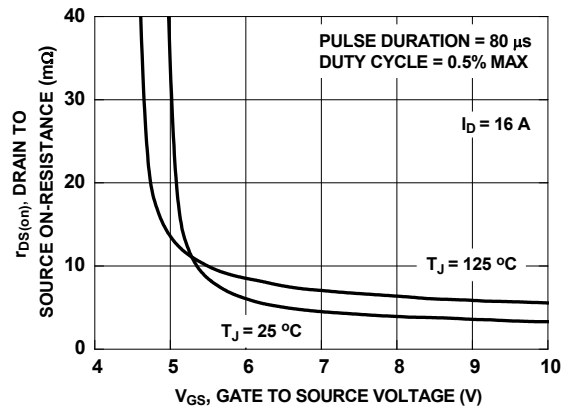

Figure 4. On Resistance vs. Gate to Source Voltage

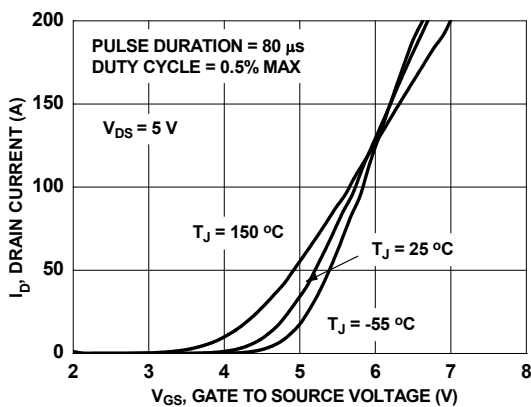

Figure 5. Transfer Characteristics

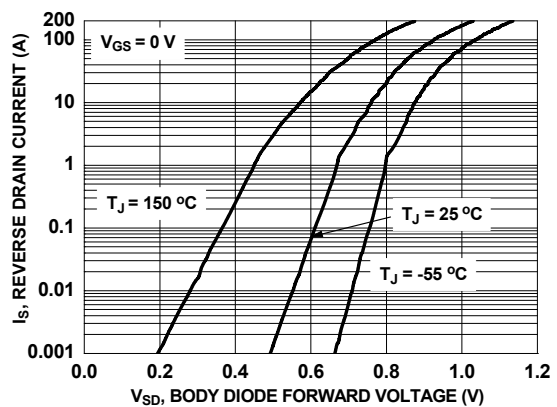

Figure 6. Source to Drain Diode Forward Voltage vs. Source Current

Typical Characteristics $T_J = 25^\circ\text{C}$ unless otherwise noted.

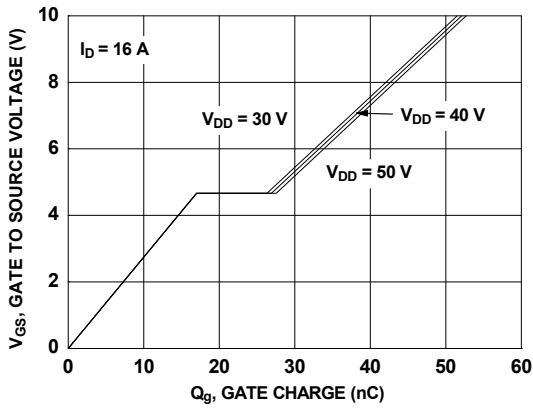

Figure 7. Gate Charge Characteristics

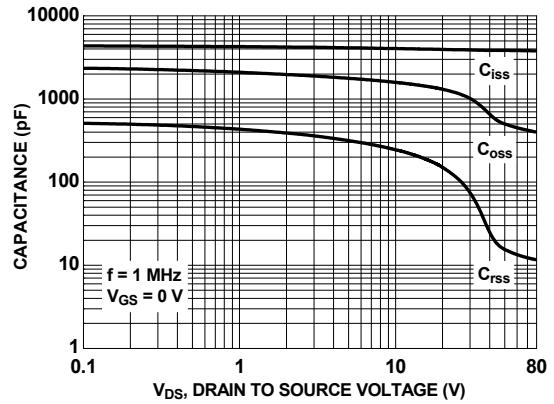

Figure 8. Capacitance vs. Drain to Source Voltage

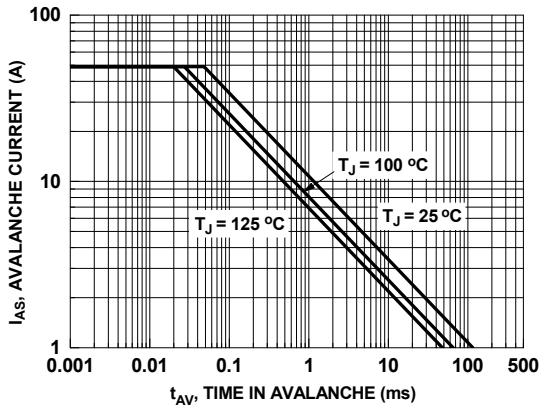

Figure 9. Unclamped Inductive Switching Capability

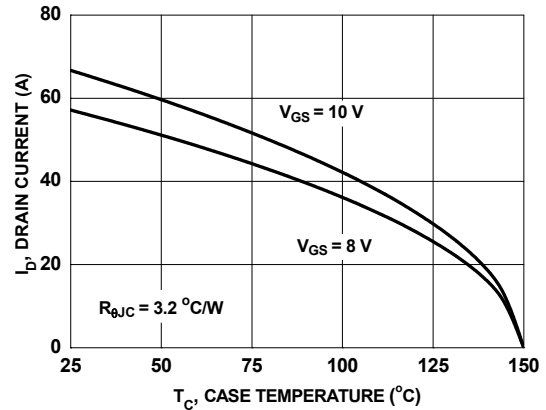

Figure 10. Maximum Continuous Drain Current vs. Case Temperature

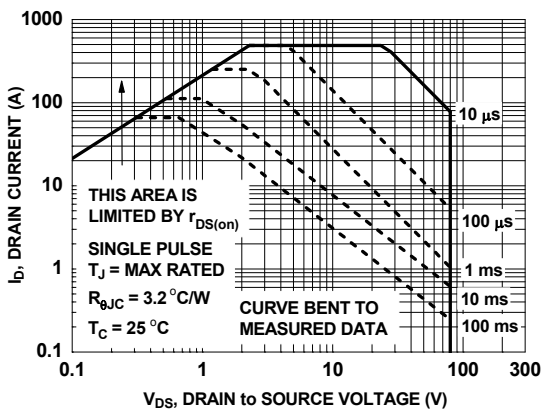

Figure 11. Forward Bias Safe Operating Area

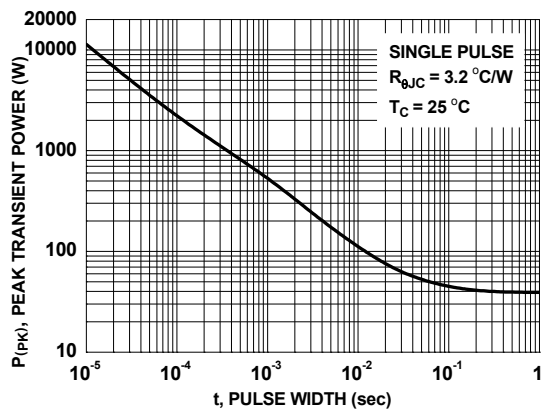

Figure 12. Single Pulse Maximum Power Dissipation

Typical Characteristics $T_J = 25\text{ }^\circ\text{C}$ unless otherwise noted.

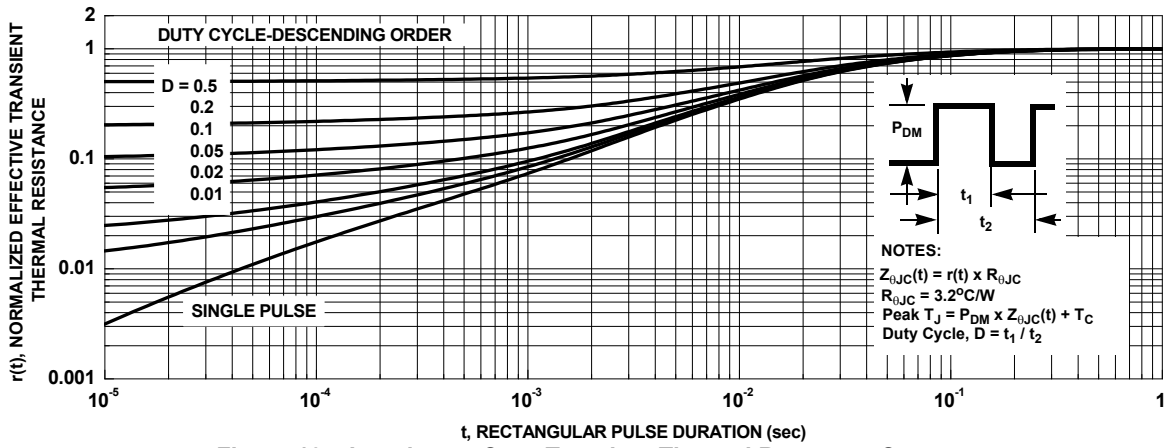
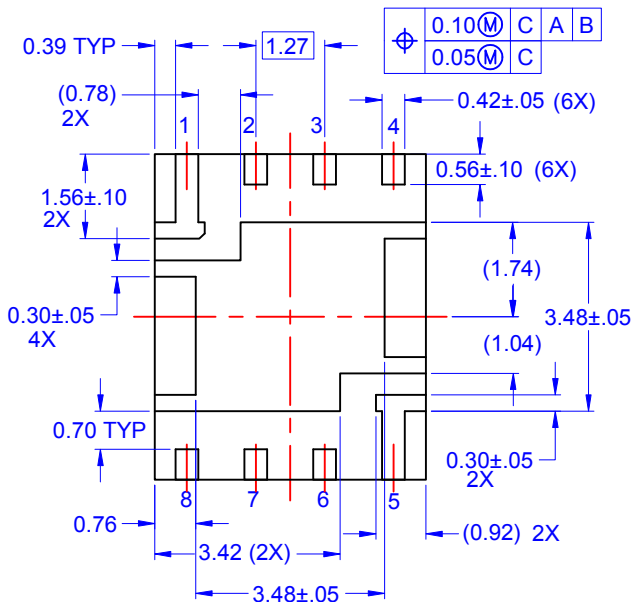
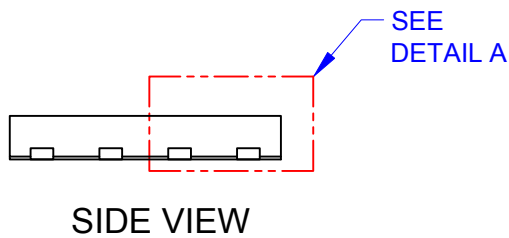
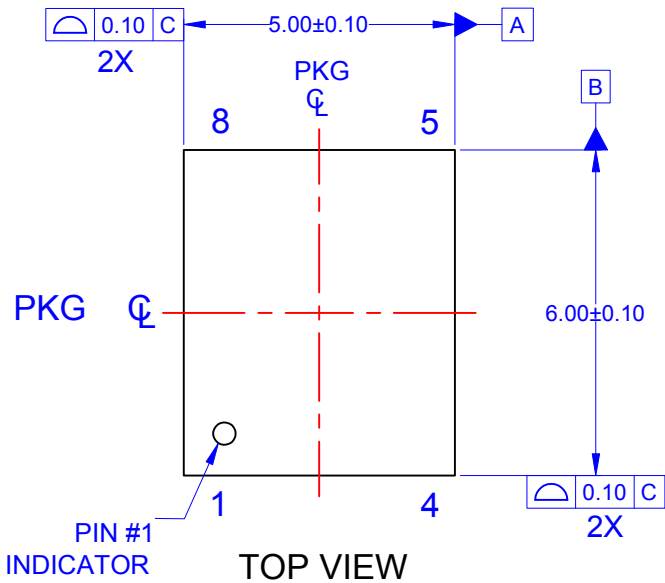
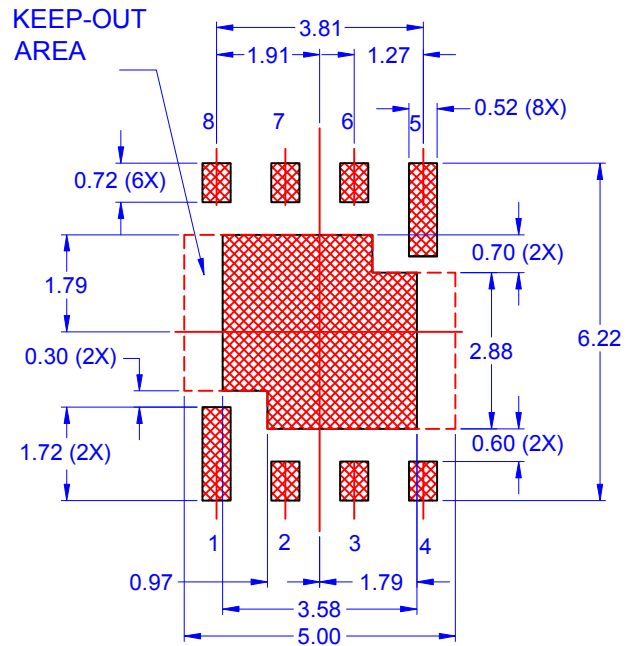

Figure 13. Junction-to-Case Transient Thermal Response Curve



BOTTOM VIEW



RECOMMENDED LAND PATTERN

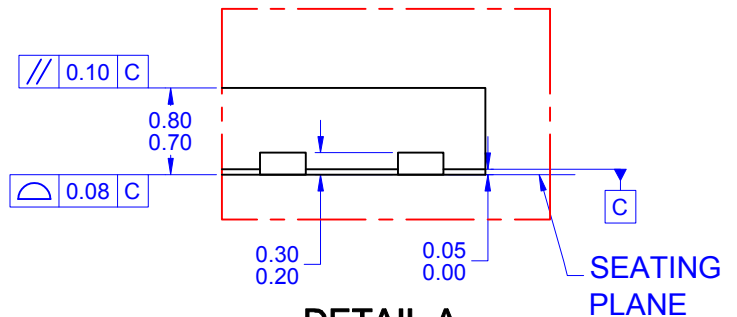

DETAIL A
(SCALE: 2X)

NOTES:

- A) PACKAGE REFERENCE : TO JEDEC REGISTRATION, MO-240B, VARIATION AA.
- B) ALL DIMENSIONS ARE IN MILLIMETERS.
- C) DIMENSIONS DO NOT INCLUDE BURRS OR MOLD FLASH. MOLD FLASH OR BURRS DOES NOT EXCEED 0.10MM.
- D) DIMENSIONING AND TOLERANCING PER ASME Y14.5M-2009
- E) IT IS RECOMMENDED TO HAVE NO TRACES OR VIAS WITHIN THE KEEP-OUT AREA
- F) DRAWING FILE NAME: PQFN08OREV1



ON Semiconductor and  are trademarks of Semiconductor Components Industries, LLC dba ON Semiconductor or its subsidiaries in the United States and/or other countries. ON Semiconductor owns the rights to a number of patents, trademarks, copyrights, trade secrets, and other intellectual property. A listing of ON Semiconductor's product/patent coverage may be accessed at www.onsemi.com/site/pdf/Patent-Marking.pdf. ON Semiconductor reserves the right to make changes without further notice to any products herein. ON Semiconductor makes no warranty, representation or guarantee regarding the suitability of its products for any particular purpose, nor does ON Semiconductor assume any liability arising out of the application or use of any product or circuit, and specifically disclaims any and all liability, including without limitation special, consequential or incidental damages. Buyer is responsible for its products and applications using ON Semiconductor products, including compliance with all laws, regulations and safety requirements or standards, regardless of any support or applications information provided by ON Semiconductor. "Typical" parameters which may be provided in ON Semiconductor data sheets and/or specifications can and do vary in different applications and actual performance may vary over time. All operating parameters, including "Typicals" must be validated for each customer application by customer's technical experts. ON Semiconductor does not convey any license under its patent rights nor the rights of others. ON Semiconductor products are not designed, intended, or authorized for use as a critical component in life support systems or any FDA Class 3 medical devices or medical devices with a same or similar classification in a foreign jurisdiction or any devices intended for implantation in the human body. Should Buyer purchase or use ON Semiconductor products for any such unintended or unauthorized application, Buyer shall indemnify and hold ON Semiconductor and its officers, employees, subsidiaries, affiliates, and distributors harmless against all claims, costs, damages, and expenses, and reasonable attorney fees arising out of, directly or indirectly, any claim of personal injury or death associated with such unintended or unauthorized use, even if such claim alleges that ON Semiconductor was negligent regarding the design or manufacture of the part. ON Semiconductor is an Equal Opportunity/Affirmative Action Employer. This literature is subject to all applicable copyright laws and is not for resale in any manner.

PUBLICATION ORDERING INFORMATION

LITERATURE FULFILLMENT:

Literature Distribution Center for ON Semiconductor
19521 E. 32nd Pkwy, Aurora, Colorado 80011 USA
Phone: 303-675-2175 or 800-344-3860 Toll Free USA/Canada
Fax: 303-675-2176 or 800-344-3867 Toll Free USA/Canada
Email: orderlit@onsemi.com

N. American Technical Support: 800-282-9855 Toll Free
USA/Canada
Europe, Middle East and Africa Technical Support:
Phone: 421 33 790 2910
Japan Customer Focus Center
Phone: 81-3-5817-1050

ON Semiconductor Website: www.onsemi.com
Order Literature: <http://www.onsemi.com/orderlit>
For additional information, please contact your local
Sales Representative