

G3VM-21HR/31HR/41HR/61HR/61HR1

MOS FET Relays SOP 6-pin, High-current and Low-ON-resistance Type

MOS FET Relays in SOP 6-pin packages that achieve the low ON resistance and high switching capacitance of a mechanical relay

- Load voltage: 20 V, 30 V, 40 V, or 60 V
- 20-V Relay: Continuous load current of 2.5 A (5 A) max.*
- 30-V Relay: Continuous load current of 4 A (8 A) max.*
- 40-V Relay: Continuous load current of 2.5 A (5 A) max.*
- 60-V Relay: Continuous load current of 3.3 A (6.6 A) max.*

* Values in parentheses are for connection C.



Note: The actual product is marked differently from the image shown here.

RoHS Compliant

Application Examples

- Semiconductor test equipment
- Security equipment
- Amusement equipment
- Communication equipment
- Industrial equipment
- Test & Measurement equipment
- Power circuit

Package

(Unit : mm, Average)

SOP 6-pin

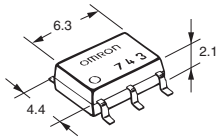

Note: The actual product is marked differently from the image shown here.

Model Number Legend

G3VM-□□□□□
1 2 3 4 5

- | | | |
|------------------------|--------------------------------|--|
| 1. Load Voltage | 2. Contact form | 3. Package |
| 2 : 20 V | 1 : 1a (SPST-NO) | H : SOP 6-pin |
| 3 : 30 V | | |
| 4 : 40 V | 4. Additional functions | 5. Other informations |
| 6 : 60 V | R: Low ON resistance | When specifications overlap, serial code is added in the recorded order. |

Ordering Information

Package	Contact form	Terminals	Load voltage (peak value) *	Continuous load current (peak value) *		Stick packaging		Tape packaging	
				Connection A, B	Connection C	Model	Minimum package quantity	Model	Minimum package quantity
SOP6	1a (SPST-NO)	Surface-mounting Terminals	20 V	2.5 A	5 A	G3VM-21HR	75	G3VM-21HR(TR)	2,500
			30 V	4 A	8 A	G3VM-31HR		G3VM-31HR(TR05)	500
			40 V	2.5 A	5 A	G3VM-41HR		G3VM-41HR(TR)	2,500
			60 V	2.3 A	4.6 A	G3VM-61HR		G3VM-61HR(TR)	2,500
				3.3 A	6.6 A	G3VM-61HR1		G3VM-61HR1(TR05)	500

* The AC peak and DC value are given for the load voltage and continuous load current.

Note: To order tape packaging for Relays with surface-mounting terminals, add "(TR)" to the end of the model number.

SOP 6-pin

■ Absolute Maximum Ratings (Ta = 25°C)

Item		Symbol	G3VM-21HR	G3VM-31HR	G3VM-41HR	G3VM-61HR	G3VM-61HR1	Unit	Measurement conditions	
Input	LED forward current	I_F	30					mA		
	LED forward current reduction rate	$\Delta I_F/^\circ\text{C}$	-0.3					mA/°C	Ta ≥ 25°C	
	LED reverse voltage	V_R	5					V		
	Connection temperature	T_J	125					°C		
Load voltage (AC peak/DC)		V_{OFF}	20	30	40	60		V		
Output	Continuous load current	Connection A	I_o	2500	4000	2500	2300	3300	mA	Connection A: AC peak/DC Connection B and C: DC
		Connection B		5000	8000	5000	4600	6600		
	Connection C									
	ON current reduction rate	Connection A	$\Delta I_o/^\circ\text{C}$	-33.3	-40	-33.3	-30.7	-33	mA/°C	G3VM-31HR/61HR1: Ta ≥ 25°C Others: Ta ≥ 50°C
		Connection B		-66.7	-80	-66.7	-61.3	-66		
Connection C										
Pulse ON current	I_{op}	7.5	12	7.5	7	10	A	t=100 ms, Duty=1/10		
Connection temperature		T_J	125					°C		
Dielectric strength between I/O (See note 1.)		V_{I-O}	1500					Vrms	AC for 1 min	
Ambient operating temperature		Ta	-40 to +85					°C	With no icing or condensation	
Ambient storage temperature		Tstg	-55 to +125					°C		
Soldering temperature		-	260					°C	10 s	

Note: 1. The dielectric strength between the input and output was checked by applying voltage between all pins as a group on the LED side and all pins as a group on the light-receiving side.

Connection Diagram

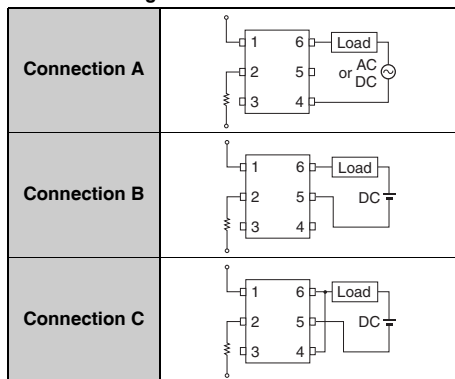

Electrical Characteristics (Ta = 25°C)

Item		Symbol		G3VM-21HR	G3VM-31HR	G3VM-41HR	G3VM-61HR	G3VM-61HR1	Unit	Measurement conditions	
Input	LED forward voltage	V _F	Minimum	1.18					V	I _F =10 mA	
			Typical	1.33							
			Maximum	1.48							
	Reverse current	I _R	Maximum	10					μA	V _R =5 V	
	Capacitance between terminals	C _T	Typical	70					pF	V=0, f=1 MHz	
Trigger LED forward current	I _{FT}	Typical	–	0.3	0.4		0.2	mA	G3VM-61HR1 : I _o =2000 mA Others : I _o =100 mA		
		Maximum	3								
Release LED forward current	I _{FC}	Minimum	0.1					mA	I _{OFF} =10 μA		
Output	Maximum resistance with output ON	R _{ON}	Typical	Connection A	0.02	0.02	0.03	0.04	0.03	Ω	G3VM-31HR: I _F =5 mA I _o =4 A (Connection A, B) I _o =8 A (C connections), t<1s Others: I _F =5 mA I _o =2 A (Connection A, B) I _o =4 A (C connections), t<1s
				Connection B	0.01	0.008	0.015	0.02	0.015		
				Connection C	0.005	0.004	0.008	0.01	0.008		
			Maximum	Connection A	0.05	0.04	0.06	0.07	0.06		
				Connection B	0.025	0.02	0.03	0.04	–		
				Connection C	–	0.01	–		–		
Current leakage when the relay is open	I _{LEAK}	Typical	–					nA	V _{OFF} = Load voltage ratings		
		Maximum	10	1000	10		20				
Capacitance between terminals	C _{OFF}	Typical	1000	1100	1000		700	pF	V=0, f=1 MHz		
		Maximum	–							1500	
Capacitance between I/O terminals	C _{I-O}	Typical	0.8					pF	f=1 MHz, V _s =0 V		
Insulation resistance between I/O terminals	R _{I-O}	Minimum	1000					MΩ	V _{I-O} =500 VDC, RoH≤60%		
		Typical	10 ⁸								
Turn-ON time	t _{ON}	Typical	1.5	1.1	1.0		0.6	ms	G3VM-21HR : I _F =5 mA, R _L =200 Ω, V _{DD} =10 V (See note 2.) Others : I _F =5 mA, R _L =200 Ω, V _{DD} =20 V (See note 2.)		
		Maximum	5								
Turn-OFF time	t _{OFF}	Typical	0.1	0.1	0.15		0.2	ms	G3VM-21HR : I _F =5 mA, R _L =200 Ω, V _{DD} =10 V (See note 2.) Others : I _F =5 mA, R _L =200 Ω, V _{DD} =20 V (See note 2.)		
		Maximum	1								

Note: 2. Turn-ON and Turn-OFF Times

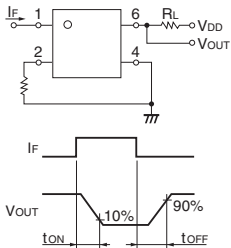

Recommended Operating Conditions

For usage with high reliability, Recommended Operation Conditions is a measure that takes into account the derating of Absolute Maximum Ratings and Electrical Characteristics.

Each item on this list is an independent condition, so it is not simultaneously satisfy several conditions.

Item	Symbol		G3VM-21HR	G3VM-31HR	G3VM-41HR	G3VM-61HR	G3VM-61HR1	Unit
Load voltage (AC peak/DC)	V _{DD}	Maximum	20	24	40	60	48	V
		Minimum	5					
Operating LED forward current	I _F	Typical	10		7.5		10	mA
		Maximum	20	25	20		25	
Continuous load current (AC peak/DC)	I _o	Maximum	2000	4000	2000	1800	3300	
Ambient operating temperature	T _a	Minimum	-20					°C
		Maximum	65					

Spacing and Insulation

Item	Minimum	Unit
Creepage distances	4.0	mm
Clearance distances	4.0	
Internal isolation thickness	0.1	

Engineering Data

LED forward current vs. Ambient temperature

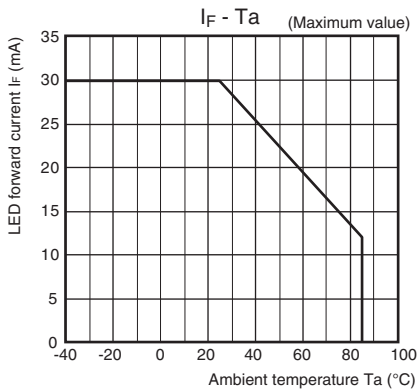

Continuous load current vs. Ambient temperature G3VM-31HR/61HR1

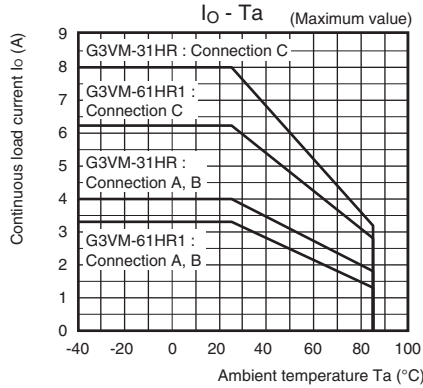

G3VM-21HR/41HR/61HR

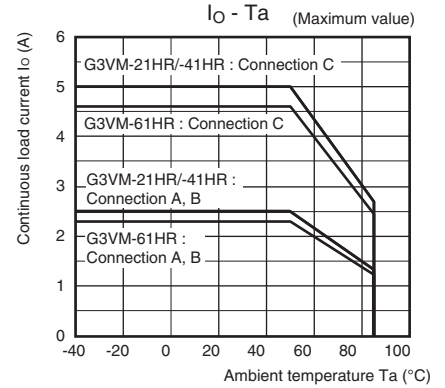

LED forward current vs. LED forward voltage

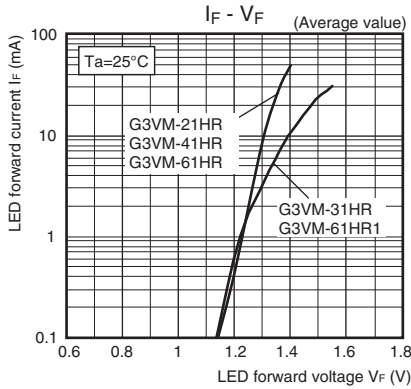

Continuous load current vs. On-state voltage

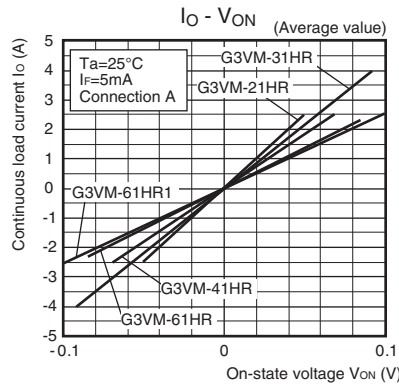

On-state resistance vs. Ambient temperature

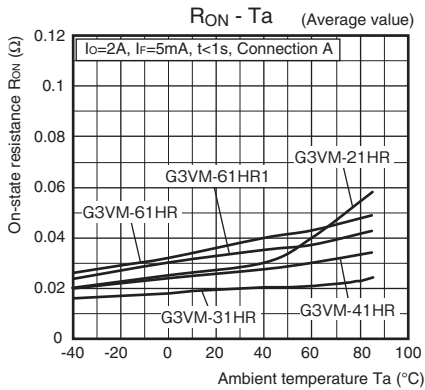

Trigger LED forward current vs. Ambient temperature

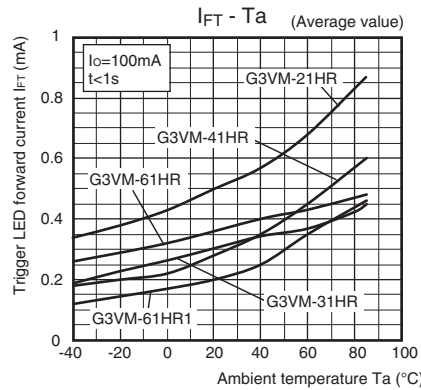

Turn ON, Turn OFF time vs. LED forward current

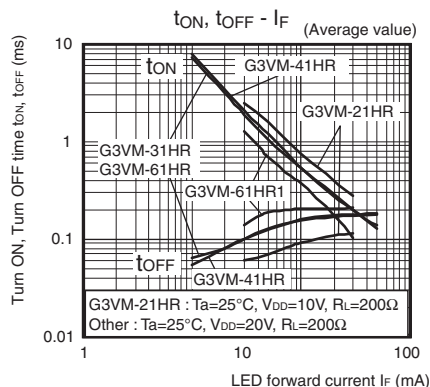

SOP

G3VM-21HR/31HR/41HR/61HR/61HR1

Engineering Data

● Turn ON, Turn OFF time vs. Ambient temperature

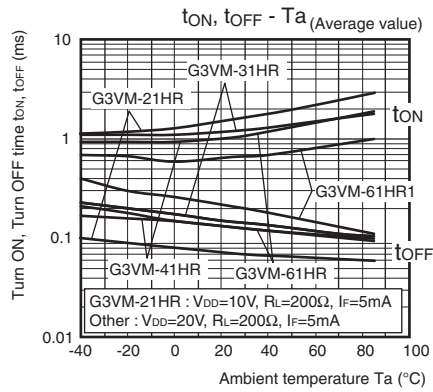

● Current leakage vs. Load voltage

G3VM-21HR/41HR/61HR

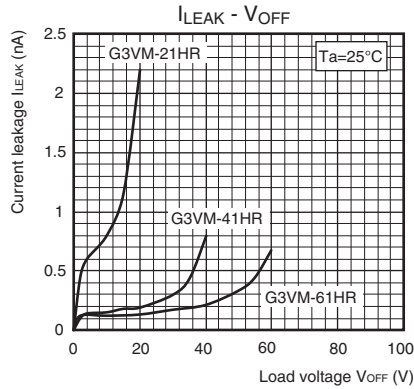

● Current leakage vs. Ambient temperature

G3VM-31HR/61HR1

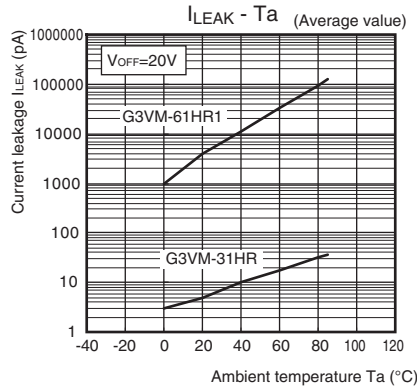

● Output terminal capacitance vs. Load voltage

G3VM-21HR/41HR/61HR

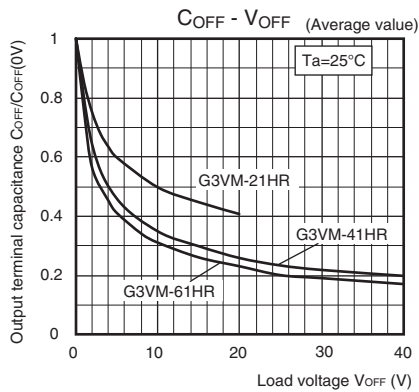

TOP

G3VM-21HR/31HR/41HR/61HR/61HR1

Appearance / Terminal Arrangement / Internal Connections

● Appearance

SOP (Small Outline Package)

SOP 6-pin

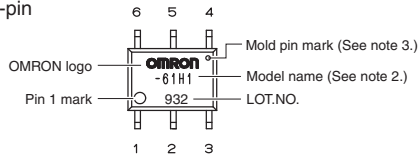

- Note: 1.** The actual product is marked differently from the image shown here.
Note: 2. "G3VM" does not appear in the model number on the Relay.
Note: 3. The indentation in the corner diagonally opposite from the pin 1 mark is from a pin on the mold.

● Terminal Arrangement/Internal Connections (Top View)

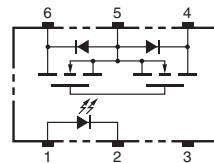

■ Dimensions (Unit: mm)

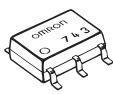

Surface-mounting Terminals

Weight: 0.13 g

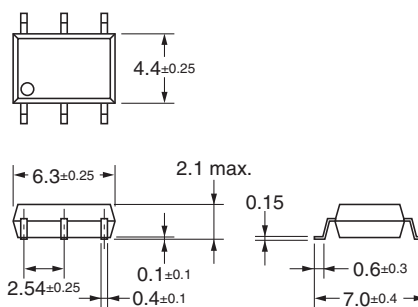

Actual Mounting Pad Dimensions

(Recommended Value, Top View)

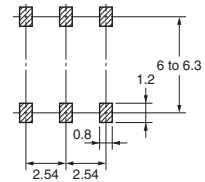

Note: The actual product is marked differently from the image shown here.

■ Approved Standards

UL recognized

Approved Standards	Contact form	File No.
UL (recognized)	1a (SPST-NO)	E80555

■ Safety Precautions

- Refer to the *Common Precautions for All MOS FET Relays* for precautions that apply to all MOS FET Relays.

• Application examples provided in this document are for reference only. In actual applications, confirm equipment functions and safety before using the product.
 • Consult your OMRON representative before using the product under conditions which are not described in the manual or applying the product to nuclear control systems, railroad systems, aviation systems, vehicles, combustion systems, medical equipment, amusement machines, safety equipment, and other systems or equipment that may have a serious influence on lives and property if used improperly. Make sure that the ratings and performance characteristics of the product provide a margin of safety for the system or equipment, and be sure to provide the system or equipment with double safety mechanisms.

Note: Do not use this document to operate the Unit.