



Grayhill, Inc.

## 62S11-M9-PH

Numero ng Bahagi:

Tagagawa / Brand:

Paglalarawan ng produkto

Mga Datasheet:

Katayuan ng RoHS

Stock Kondisyon

Ipadala Mula

Pagpapadala ng Way

62S11-M9-PH

Grayhill, Inc.

ROTARY ENCODER OPTICAL 32PPR

 62S11-M9-PH.pdf

 Lead free / RoHS Compliant

1744 pcs stock

Hong Kong

DHL/Fedex/TNT/UPS/EMS

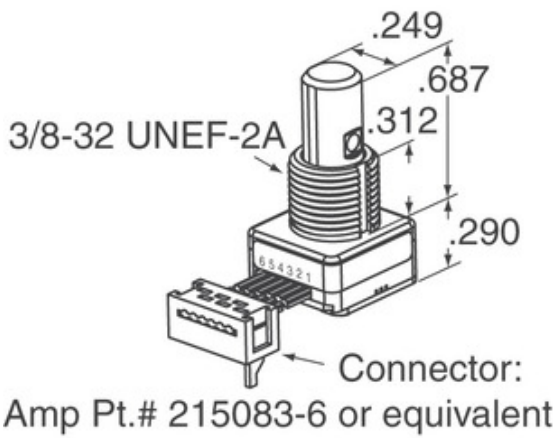
**HUMILING NG PANIPI**

Ang imahe ay maaaring representasyon. Tingnan ang mga pagtutukoy para sa mga detalye ng produkto.

### Mga pagtutukoy ng 62S11-M9-PH

NUMERO NG BAHAGI	62S11-M9-PH
MANUFACTURER	Grayhill, Inc.
PAGLALARAWAN	ROTARY ENCODER OPTICAL 32PPR
LEAD FREE STATUS / KATAYUAN NG ROHS	Lead free / RoHS Compliant
AVAILABLE ANG DAMI	1744 pcs
DATA SHEET	 62S11-M9-PH.pdf
BOLTAHE - SUPPLY	5V
PAGWAWAKAS STYLE	PC Pin
SERYE	62S
PALITIN LIFE (CYCLES MIN)	1M
PULSES PER REVOLUTION	32
TYPE OUTPUT	Quadrature (Incremental)
IBANG PANGALAN	62S11M9PH
ORYENTASYON	Vertical
SALALAYAN TYPE	PCB, Through Hole
ANG SENSITIVITY LEVEL (MSL)	1 (Unlimited)
LEAD LIBRENG STATUS / KATAYUAN NG ROHS	Lead free / RoHS Compliant
TYPE ENCODER	Optical
DITENT	Yes
ITINAYO NOONG LUMIPAT	Yes
TYPE ACTUATOR	1/4" Dia Flatted End

### Kaugnay na Mga Tag

Grayhill, Inc. 62S11-M9-PH	62S11-M9-PH Distributor	62S11-M9-PH Supplier
62S11-M9-PH Presyo	62S11-M9-PH Pictures	62S11-M9-PH Image
62S11-M9-PH PDF Datasheet	62S11-M9-PH I-download ang Datasheet	62S11-M9-PH Datasheet
62S11-M9-PH Stock	Bumili ng 62S11-M9-PH	Bumili Grayhill, Inc. 62S11-M9-PH
Grayhill, Inc. 62S11-M9-PH	Grayhill, Inc. Supplier	Grayhill, Inc. Distributor
Grayhill, Inc. 62S11-M9-PH	Grayhill Inc. 62S11-M9-PH	

### Kaugnay na Mga Produkto

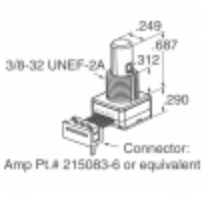
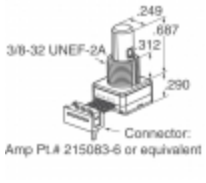
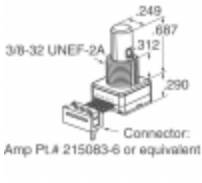
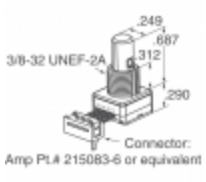
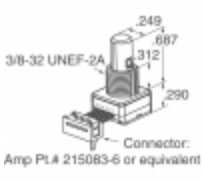
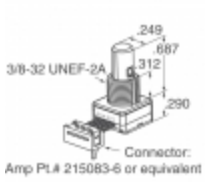
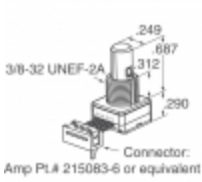
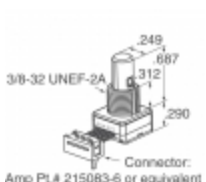
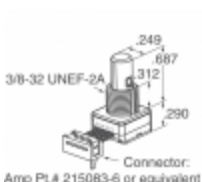
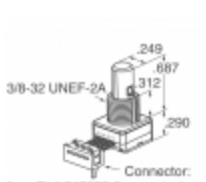
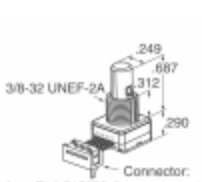
 <p><b>62S11-N0-040CH</b> Mga Tagagawa: Grayhill, Inc. Paglalarawan: ROTARY ENCODER OPT 32PPR 4" CBL Sa stock: 2486 pcs</p> <p><b>RFQ</b></p>	 <p><b>62S11-M9-095CH</b> Mga Tagagawa: Grayhill, Inc. Paglalarawan: ROTARY ENCODER OPTICAL 32PPR Sa stock: 1978 pcs</p> <p><b>RFQ</b></p>
 <p><b>62S11-N0-020SH</b> Mga Tagagawa: Grayhill, Inc. Paglalarawan: ROTARY ENCODER OPTICAL 32PPR Sa stock: 2229 pcs</p> <p><b>RFQ</b></p>	 <p><b>62S11-M9-P</b> Mga Tagagawa: Grayhill, Inc. Paglalarawan: ROTARY ENCODER OPTICAL 32PPR Sa stock: 1799 pcs</p> <p><b>RFQ</b></p>
 <p><b>62S11-M9-100C</b> Mga Tagagawa: Grayhill, Inc. Paglalarawan: ROTARY ENCODER OPTICAL 32PPR Sa stock: 2260 pcs</p> <p><b>RFQ</b></p>	 <p><b>62S11-M9-100S</b> Mga Tagagawa: Grayhill, Inc. Paglalarawan: ROTARY ENCODER OPTICAL 32PPR Sa stock: 2008 pcs</p> <p><b>RFQ</b></p>
 <p><b>62S11-N0-040C</b> Mga Tagagawa: Grayhill, Inc. Paglalarawan: ROTARY ENCODER OPT 32PPR 4" CBL Sa stock: 1995 pcs</p> <p><b>RFQ</b></p>	 <p><b>62S11-N0-020S</b> Mga Tagagawa: Grayhill, Inc. Paglalarawan: ROTARY ENCODER OPTICAL 32PPR Sa stock: 2261 pcs</p> <p><b>RFQ</b></p>
 <p><b>62S11-N0-020C</b> Mga Tagagawa: Grayhill, Inc. Paglalarawan: ROTARY ENCODER OPTICAL 32PPR Sa stock: 1781 pcs</p> <p><b>RFQ</b></p>	 <p><b>62S11-M9-060C</b> Mga Tagagawa: Grayhill, Inc. Paglalarawan: ROTARY ENCODER OPTICAL 32PPR Sa stock: 2060 pcs</p> <p><b>RFQ</b></p>
 <p><b>62S11-M9-120S</b> Mga Tagagawa: Grayhill, Inc. Paglalarawan: ROTARY ENCODER OPTICAL 32PPR Sa stock: 2092 pcs</p> <p><b>RFQ</b></p>	 <p><b>62S11-N0-020CH</b> Mga Tagagawa: Grayhill, Inc. Paglalarawan: ROTARY ENCODER OPTICAL 32PPR Sa stock: 2062 pcs</p> <p><b>RFQ</b></p>

Copyright © 2020 maasahang distributor ng electronic components.

E-mail: [Info@infinity-electronic.com](mailto:Info@infinity-electronic.com)

Address: 17F, Gaylord Commercial Building, 114-118 Lockhart Road, Wan Chai, Hong Kong

