



Grayhill, Inc.

62S11-N5-050C

Numero ng Bahagi:

62S11-N5-050C

Tagagawa / Brand:

Grayhill, Inc.

Paglalarawan ng produkto

ROTARY ENCODER OPTICAL 32PPR

Mga Datasheet:

 62S11-N5-050C.pdf

Katayuan ng RoHS

 Lead free / RoHS Compliant

Stock Kondisyon

1936 pcs stock

Ipadala Mula

Hong Kong

Pagpapadala ng Way

DHL/Fedex/TNT/UPS/EMS

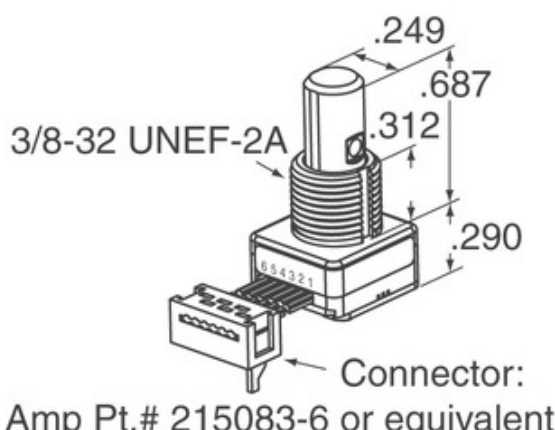
HUMILING NG PANIPI

Ang imahe ay maaaring representasyon. Tingnan ang mga pagtutukoy para sa mga detalye ng produkto.





Mga pagtutukoy ng 62S11-N5-050C

NUMERO NG BAHAGI	62S11-N5-050C
MANUFACTURER	Grayhill, Inc.
PAGLALARAWAN	ROTARY ENCODER OPTICAL 32PPR
LEAD FREE STATUS / KATAYUAN NG ROHS	Lead free / RoHS Compliant
AVAILABLE ANG DAMI	1936 pcs
DATA SHEET	 62S11-N5-050C.pdf
BOLTAHE - SUPPLY	5V
PAGWAWAKAS STYLE	Cable with Connector
SERYE	62S
PALITIN LIFE (CYCLES MIN)	1M
PULSES PER REVOLUTION	32
TYPE OUTPUT	Quadrature (Incremental)
IBANG PANGALAN	62S11N5050C
ORYENTASYON	Vertical
SALALAYAN TYPE	Panel Mount
ANG SENSITIVITY LEVEL (MSL)	1 (Unlimited)
LEAD LIBRENG STATUS / KATAYUAN NG ROHS	Lead free / RoHS Compliant
TYPE ENCODER	Optical
DITENT	No
ITINAYO NOONG LUMIPAT	Yes
TYPE ACTUATOR	1/4" Dia Flatted End

Kaugnay na Mga Tag

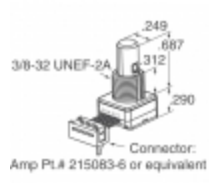
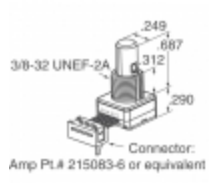
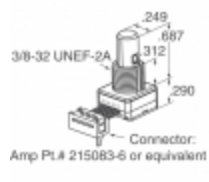
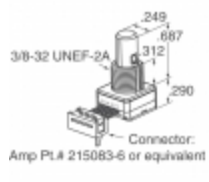
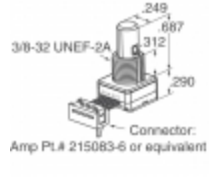
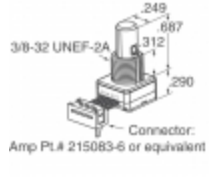
Grayhill, Inc. 62S11-N5-050C	62S11-N5-050C Distributor	62S11-N5-050C Supplier
62S11-N5-050C Presyo	62S11-N5-050C Pictures	62S11-N5-050C Image
62S11-N5-050C PDF Datasheet	62S11-N5-050C I-download ang Datasheet	62S11-N5-050C Datasheet
62S11-N5-050C Stock	Bumili ng 62S11-N5-050C	Bumili Grayhill, Inc. 62S11-N5-050C
Grayhill, Inc. 62S11-N5-050C	Grayhill, Inc. Supplier	Grayhill, Inc. Distributor
Grayhill, Inc. 62S11-N5-050C	Grayhill Inc. 62S11-N5-050C	

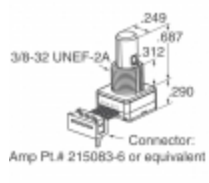
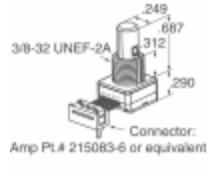
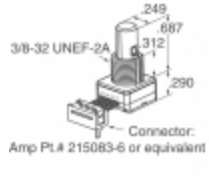
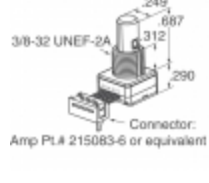
Kaugnay na Mga Produkto

 <p>62S11-N5-040C Mga Tagagawa: Grayhill, Inc. Paglalarawan: ROTARY ENCODER OPTICAL 32PPR Sa stock: 2106 pcs</p> <p>RFQ</p>	 <p>62S11-N5-120S Mga Tagagawa: Grayhill, Inc. Paglalarawan: ROTARY ENCODER OPTICAL 32PPR Sa stock: 1675 pcs</p> <p>RFQ</p>
 <p>62S11-N5-100C Mga Tagagawa: Grayhill, Inc. Paglalarawan: ROTARY ENCODER OPTICAL 32PPR Sa stock: 1789 pcs</p> <p>RFQ</p>	 <p>62S11-N5-080SH Mga Tagagawa: Grayhill, Inc. Paglalarawan: ROTARY ENCODER OPTICAL 32PPR Sa stock: 1942 pcs</p> <p>RFQ</p>
 <p>62S11-N4-120S Mga Tagagawa: Grayhill, Inc. Paglalarawan: ROTARY ENCODER OPTICAL 32PPR Sa stock: 2038 pcs</p> <p>RFQ</p>	 <p>62S11-N4-PH Mga Tagagawa: Grayhill, Inc. Paglalarawan: ROTARY ENCODER OPTICAL 32PPR Sa stock: 1970 pcs</p> <p>RFQ</p>
 <p>62S11-N5-025C Mga Tagagawa: Grayhill, Inc. Paglalarawan: ROTARY ENCODER OPTICAL 32PPR Sa stock: 2408 pcs</p> <p>RFQ</p>	 <p>62S11-N5-P Mga Tagagawa: Grayhill, Inc. Paglalarawan: ROTARY ENCODER OPTICAL 32PPR Sa stock: 1885 pcs</p> <p>RFQ</p>
 <p>62S11-N5-060SH Mga Tagagawa: Grayhill, Inc. Paglalarawan: ROTARY ENCODER OPTICAL 32PPR Sa stock: 2263 pcs</p> <p>RFQ</p>	 <p>62S11-N4-P Mga Tagagawa: Grayhill, Inc. Paglalarawan: ROTARY ENCODER OPTICAL 32PPR Sa stock: 1912 pcs</p> <p>RFQ</p>
 <p>62S11-N5-060C Mga Tagagawa: Grayhill, Inc. Paglalarawan: ROTARY ENCODER OPTICAL 32PPR Sa stock: 2164 pcs</p> <p>RFQ</p>	 <p>62S11-N5-025CH Mga Tagagawa: Grayhill, Inc. Paglalarawan: ROTARY ENCODER OPTICAL 32PPR Sa stock: 2083 pcs</p> <p>RFQ</p>

Copyright © 2020 maasahang distributor ng electronic components.

E-mail: Info@infinity-electronic.com

Address: 17F, Gaylord Commercial Building, 114-118 Lockhart Road, Wan Chai, Hong Kong

