



Grayhill, Inc.

62S11-N4-P

Numero ng Bahagi:

62S11-N4-P

Tagagawa / Brand:

Grayhill, Inc.

Paglalarawan ng produkto

ROTARY ENCODER OPTICAL 32PPR

Mga Datasheet:

 62S11-N4-P.pdf

Katayuan ng RoHS

 Lead free / RoHS Compliant

Stock Kondisyon

1912 pcs stock

Ipadala Mula

Hong Kong

Pagpapadala ng Way

DHL/Fedex/TNT/UPS/EMS

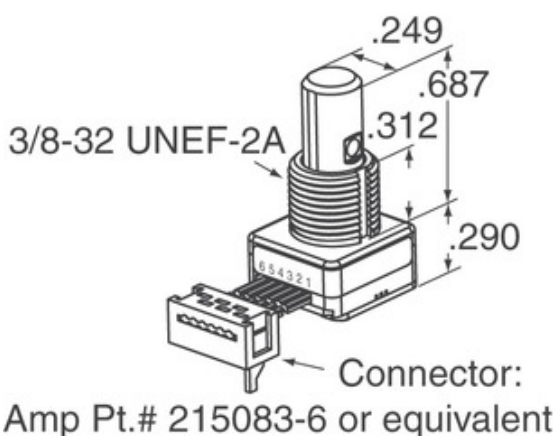
HUMILING NG PANIPI

Ang imahe ay maaaring representasyon. Tingnan ang mga pagtutukoy para sa mga detalye ng produkto.





Mga pagtutukoy ng 62S11-N4-P

NUMERO NG BAHAGI	62S11-N4-P
MANUFACTURER	Grayhill, Inc.
PAGLALARAWAN	ROTARY ENCODER OPTICAL 32PPR
LEAD FREE STATUS / KATAYUAN NG ROHS	Lead free / RoHS Compliant
AVAILABLE ANG DAMI	1912 pcs
DATA SHEET	 62S11-N4-P.pdf
BOLTAHE - SUPPLY	5V
PAGWAWAKAS STYLE	PC Pin
SERYE	62S
PALITIN LIFE (CYCLES MIN)	1M
PULSES PER REVOLUTION	32
TYPE OUTPUT	Quadrature (Incremental)
IBANG PANGALAN	62S11N4P
ORYENTASYON	Vertical
SALALAYAN TYPE	PCB, Through Hole
ANG SENSITIVITY LEVEL (MSL)	1 (Unlimited)
LEAD LIBRENG STATUS / KATAYUAN NG ROHS	Lead free / RoHS Compliant
TYPE ENCODER	Optical
DITENT	No
ITINAYO NOONG LUMIPAT	Yes
TYPE ACTUATOR	1/4" Dia Flatted End

Kaugnay na Mga Tag

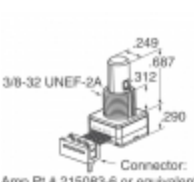
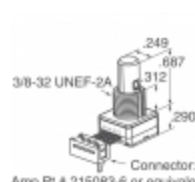
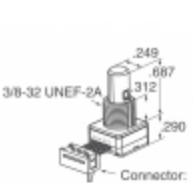
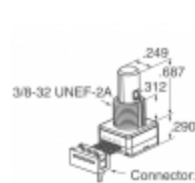
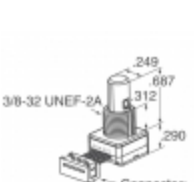
Grayhill, Inc. 62S11-N4-P	62S11-N4-P Distributor	62S11-N4-P Supplier
62S11-N4-P Presyo	62S11-N4-P Pictures	62S11-N4-P Image
62S11-N4-P PDF Datasheet	62S11-N4-P I-download ang Datasheet	62S11-N4-P Datasheet
62S11-N4-P Stock	Bumili ng 62S11-N4-P	Bumili Grayhill, Inc. 62S11-N4-P
Grayhill, Inc. 62S11-N4-P	Grayhill, Inc. Supplier	Grayhill, Inc. Distributor
Grayhill, Inc. 62S11-N4-P	Grayhill Inc. 62S11-N4-P	

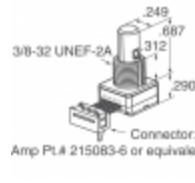
Kaugnay na Mga Produkto

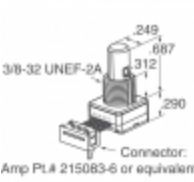
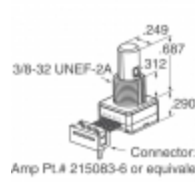
 <p>62S11-N4-025CH Mga Tagagawa: Grayhill, Inc. Paglalarawan: ROTARY ENCODER OPTICAL 32PPR Sa stock: 1946 pcs</p> <p>RFQ</p>	 <p>62S11-N3-PH Mga Tagagawa: Grayhill, Inc. Paglalarawan: ROTARY ENCODER OPTICAL 32PPR Sa stock: 1856 pcs</p> <p>RFQ</p>
 <p>62S11-N4-060SH Mga Tagagawa: Grayhill, Inc. Paglalarawan: ROTARY ENCODER OPTICAL 32PPR Sa stock: 2262 pcs</p> <p>RFQ</p>	 <p>62S11-N4-120S Mga Tagagawa: Grayhill, Inc. Paglalarawan: ROTARY ENCODER OPTICAL 32PPR Sa stock: 2038 pcs</p> <p>RFQ</p>
 <p>62S11-N5-050C Mga Tagagawa: Grayhill, Inc. Paglalarawan: ROTARY ENCODER OPTICAL 32PPR Sa stock: 1936 pcs</p> <p>RFQ</p>	 <p>62S11-N4-020C Mga Tagagawa: Grayhill, Inc. Paglalarawan: ROTARY ENCODER OPTICAL 32PPR Sa stock: 2083 pcs</p> <p>RFQ</p>
 <p>62S11-N5-025C Mga Tagagawa: Grayhill, Inc. Paglalarawan: ROTARY ENCODER OPTICAL 32PPR Sa stock: 2408 pcs</p> <p>RFQ</p>	 <p>62S11-N5-040C Mga Tagagawa: Grayhill, Inc. Paglalarawan: ROTARY ENCODER OPTICAL 32PPR Sa stock: 2106 pcs</p> <p>RFQ</p>
 <p>62S11-N4-025C Mga Tagagawa: Grayhill, Inc. Paglalarawan: ROTARY ENCODER OPTICAL 32PPR Sa stock: 1970 pcs</p> <p>RFQ</p>	 <p>62S11-N5-025CH Mga Tagagawa: Grayhill, Inc. Paglalarawan: ROTARY ENCODER OPTICAL 32PPR Sa stock: 2083 pcs</p> <p>RFQ</p>
 <p>62S11-N4-PH Mga Tagagawa: Grayhill, Inc. Paglalarawan: ROTARY ENCODER OPTICAL 32PPR Sa stock: 1970 pcs</p> <p>RFQ</p>	 <p>62S11-N5-060C Mga Tagagawa: Grayhill, Inc. Paglalarawan: ROTARY ENCODER OPTICAL 32PPR Sa stock: 2164 pcs</p> <p>RFQ</p>

Copyright © 2020 maasahang distributor ng electronic components.

E-mail: Info@infinity-electronic.com

Address: 17F, Gaylord Commercial Building, 114-118 Lockhart Road, Wan Chai, Hong Kong

